

INSTALLATION & TECHNICAL INFORMATION

PLEASE READ PRIOR TO INSTALLATION



Moflash Intrinsically Safe Sounder-Beacon Range

S00605, Issue 7, 28/07/2020

VISUAL AND/OR AUDIBLE SIGNALLING DEVICES

APPROVALS AND CONFORMITIES



1.0 Introduction

The Moflash Intrinsically Safe Sounder-Beacon Range of products (IS-SB-02-xxxx) are ATEX and IECEx certified. This range is approved to be installed in Groups I (Mining) and Group II (above ground), Zones 0, 1 or 2 with gas groups IIA, IIB, IIC and Zones 20, 21 and 22 for dust groups IIIC and carries a temperature classification of T5. The Sounder-Beacon Range has a total of 32 alarm tones selectable via a DIP switch which is set upon installation. This switch also gives the option to change the 1Hz flash signal (Automatically Synchronised to the Sounder Tone) to a static (constantly on) signal. When powered via a suitable Galvanic Isolator or Zener Barrier, the Sounder will draw a constant 33mA. The Sounder has diode reverse polarity protection and is also End of Line resistor compatible.

2.0 Intrinsically Safe Labelling

The product will have an individual serial number printed onto the head base plate. An example of the sounder label is shown below:

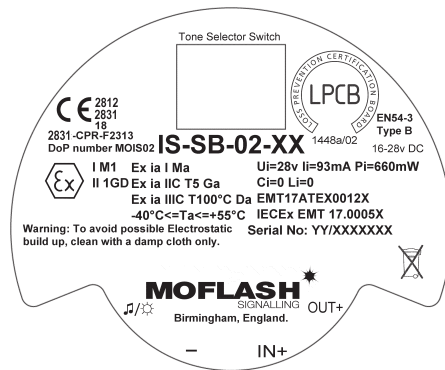

These products have been tested by notified body **Element Materials Technology Rotterdam** who are UKAS accredited to BS EN ISO/IEC 17025:2005 and ISO/IEC 17065:2012. It is also a Notified Body for the ATEX Directive, an IECEx Certification Body and an IECEx Testing Laboratory.

The suffix X at the end of the certificate numbers indicates that there are special clauses added for safe use of these units.

3.0 Types of Approval and Standards Applied

The Moflash IS Sounder product has been approved to the following standards:
IEC 60079-0:2011 / EN 60079-0:2012 + A11:2013
IEC 60079-11:2011 / EN 60079-11:2012
EN 54-3:2001+A1:2002+A2:2006

4.0 Zones, Gas Groups and Temperature Classifications

The Moflash Intrinsically Safe Sounder-Beacon Range is certified to the following:

Ex ia IIC T5 Ga, Ex ia IIIC T100C Da, Ex ia I Ma.

This means that the units can be installed in locations with the following conditions when connected to an approved system:

Zones

Zone 0	Explosive gas air mixture continuously present.
Zone 1	Explosive gas air mixture likely to occur in normal operation.
Zone 2	Explosive gas air mixture not likely to occur, and if it does, it will only exist for a short time.
Zone 20	Explosive dust air mixture is continuously present.
Zone 21	Explosive dust air mixture likely to occur in normal operation.
Zone 22	Explosive dust air mixture not likely to occur, and if it does, it will only exist for a short time.

Gas Groupings

IIA Propane Group, IIB Ethylene Group and IIC Hydrogen and Acetylene
M1 Methane, Carbon Dust

Equipment Category

1GD & M1 Temperature Range: $-40^{\circ}\text{C} < T_a < 55^{\circ}\text{C}$

Dust

IIIA Fibres and Flying, IIIB Flour and Grain, IIIC Coal Dust and Metal Dust.

The maximum surface temperature of operating product in the Sounder will not exceed 100°C .

A Declaration of Conformity and also the Sounder Range ATEX and IECEx Certificates are available on request or alternately visit www.Moflash.co.uk.

5.0 Installation

The TimeSaver base enables quick and easy installation of these units with no extra cabling to be made to the head of the unit. Connections are made to the base during the initial wiring phase which results in a faster and more reliable installation. The head unit ‘twists and clicks’ into the base on commissioning, thus avoiding any wiring and connection problems associated with traditional installations.

If required, the mechanism for locking the head unit to the base can be activated by removing the thin section of plastic shown in Fig. 1 with side cutters or similar tool. To open a locked head, remove the small rubber bung from the hole on the side of the head unit, insert a tool into the hole and depress the clip whilst twisting the head.

An alternative locking method is shown in Fig. 1b. Drive the hexagonal locking screw forward by turning a 1.5mm hexagonal key clockwise until the head is locked.

The O-ring and bung must be re-fitted to maintain the weatherproofing.

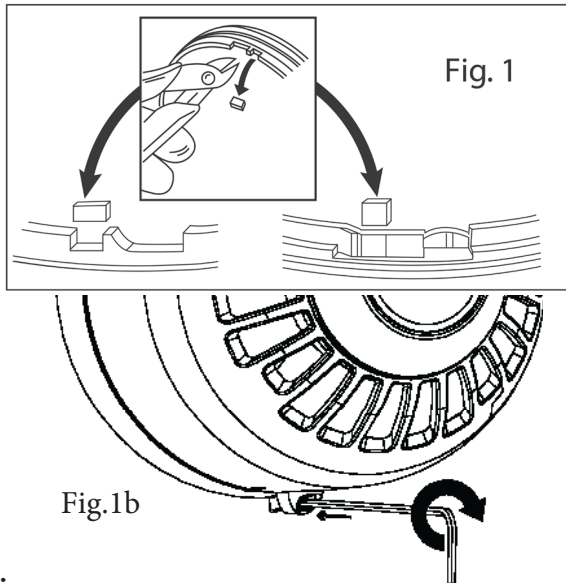

General Requirement

The Sounder-Beacon must be installed in accordance with the latest EN60079-0 specification or equivalent IEC specification. With consideration for any local installation requirements and should only be carried out by appropriately competent and qualified personnel.

- The location of the Sounder-Beacon should be chosen with due regard to the area over which the signalling device must be audible/visible.
- These units are suitable for wall or ceiling mount **only**.
- Environmental exposure conditions during installation should be dry. Moist or wet conditions should be avoided.
- Avoid mounting the product where it may be subjected to excessive vibration.

To mount the unit

- Remove the head from the base by rotating anticlockwise until it comes free.
- Remove the appropriate fixing hole and conduit knockouts from the back box.
- The back box provides IP66* protection. For this to be maintained, suitably rated (minimum IP66) M20 cable glands must also be used for cable entry/exit.
- Insert cable glands and attach to surface.
- Select required wiring option for required operation (see wiring section).
- Select tone by configuring the DIP switches in the head unit, the tone table can be found on page 12 of this booklet (Pre-set to tone 18).
- Select Light output option (see table below).

Light Output	Switch 6 Position
Flashing	OFF
Static	ON

- Relocate head onto mounted base unit & rotate clockwise until locked in place.

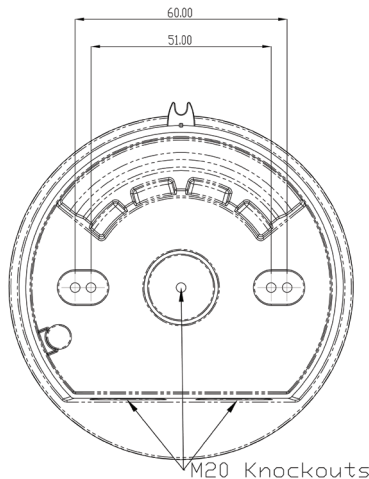

6.0 Wiring

Line	Terminal Marking
Common Positive Supply IN	(3) IN+
Sounder Negative Supply	(2) -
Beacon Negative Supply	(1) 🎵/☀️

Table above indicates markings inside the base of the unit for wiring connections. Each unit must be powered via an approved Zener Barrier or Galvanic Isolator with entity parameters that do not exceed:

Uo:28v, Io: 93mA, Po:660mW, Ci:0, Li:0

The combined Sounder Beacon can be operated in 3 ways, Sounder only, Beacon only or Sounder Beacon combined. This is shown in the table below:

Line	Terminal Marking	Beacon Active	Sounder Active	Both Active
Common Positive Supply IN (Uo)	(3) IN+	+	+	+
Sounder Negative Supply	(2) -		-	-
Beacon Negative Supply	(1) 🎵/☀️	-		-

Combined Sounder and Beacon Alarm

Before final installation of the IS-SB-02 head unit onto the installed base, the alarm tone and light output must be set (see page 5).

To activate both Sounder and Beacon together, the negative supplies need to be connected together via a wire link (not supplied) in the base of the unit (see picture below).

This wire must conform to correct standards as required by the Intrinsically Safe installation (EN 60079-0:2012 + A11:2013, EN 60079-11:2012, EN 50303:2000), minimum wire gauge of 24AWG copper wire required.



Connection into the unit must be via a suitably rated Zener Barrier/Galvanic Isolator, the connections for combined operation are below.

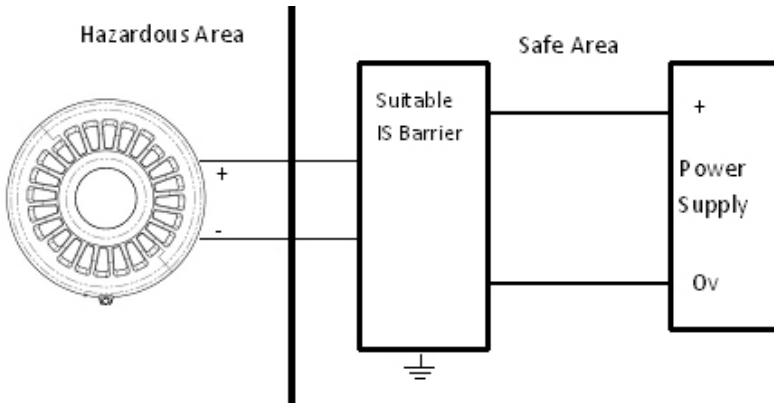

Independant Sounder/Beacon Alarm

When the Sounder and Beacon are required to operate independantly, this is done by switching the negative connections as shown in the table on page 6. There are a number of ways for this to be accomplished through the suitable barriers, a number of methods are shown below:

For this application, a barrier with 2 Diode return paths is required as shown in the diagram below:

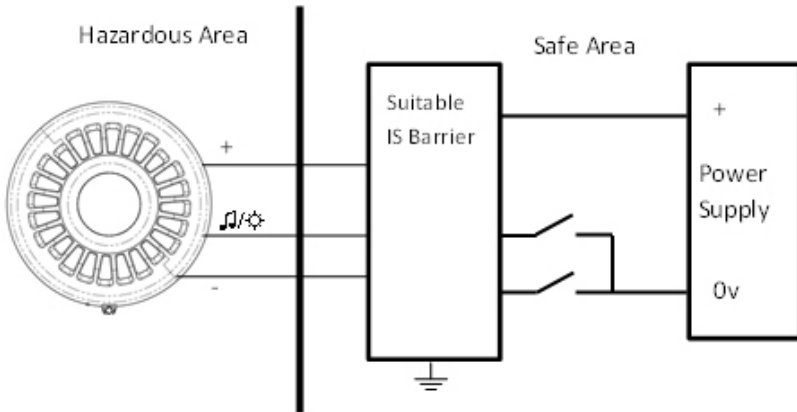

Switching between return paths will enable either Sounder or Beacon, alternately, both the paths could be actived to power both sections together.

Galvanic Isolator

The IS-SB-02-XX Intrinsically Safe Sounder Beacon Range is compatible for use with suitably rated Galvanic Isolators. The Galvanic Isolators have the advantage of not requiring an isolated high integrity earth to be installed to connect the Zener Barriers. These Isolators are often more expensive per unit but may reduce installation costs as the earth is not required.

The IS-SB-02-XX range can be powered by the Galvanic Isolators with matching parameters as described in the entity parameters section of the installation sheet. The combined unit can be turned on and off either by using a suitably placed switch in the positive or negative rails (switch must be of suitable ratings if installed in the Hazardous Area), or by turning the Galvanic Isolator on and off. For both applications the wire link described on page 6 will be required.

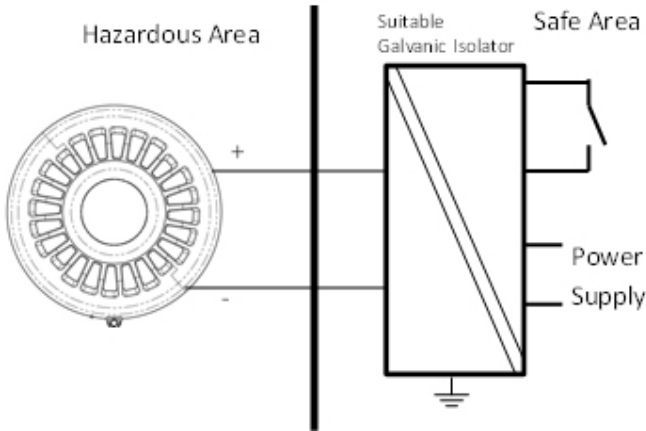

As with the Zener barriers, the Sounder and the Beacon can be triggered independently when using Galvanic Isolators, however an additional Intrinsically Safe relay is required to make the additional connection.

As with all equipment in the system, the correct ratings must be maintained to keep the integrity and safety to the correct levels. The relay can be switched to change between Sounder or Beacon or Both.

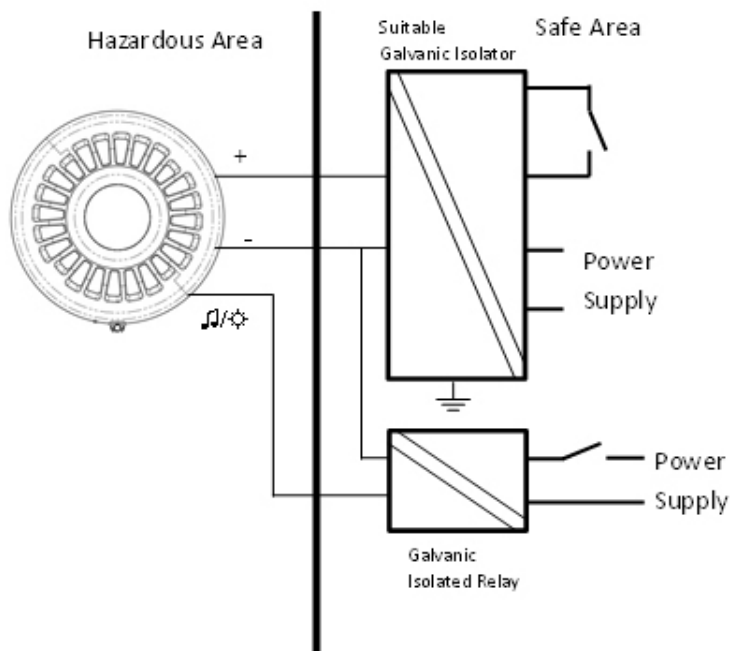

End of line monitoring is applicable to the Sounder Product. For this to function correctly, the resistor must be connected between the IN+ terminal and the Sounder Negative Supply. A suitable Zener Barrier which can allow reverse polarity monitoring to take place and a fire panel compatible with Intrinsically Safe products must also be used.

If required, an external switch can be wired in series with the (1) and/or (2) connections to give independent remote change over from Sounder to Beacon. This switch must conform to Intrinsically Safe installation (EN 60079-0:2012 + A11:2013, EN 60079-11:2012, EN 50303:2000).

7.0 Maintenance

Little or no maintenance is required during the normal working life of the product. The Moflash Intrinsically Safe enclosures are resistant to most acids, alkalis and chemicals and have been designed to withstand severe weather conditions. However it is suggested that continuous supervision and periodic inspections may be required in relation to the requirements of the installation as per IEC 60079-17.

To avoid the possibility of a potential electrostatic charge build up, it is recommended that the exterior of the product is periodically wiped down with a clean damp cloth. At this point a visual inspection is recommended to ensure that the product is in good working order and no damage has been sustained during its normal operation.

The enclosure is non-conducting and may generate an ignition-capable level of electrostatic charge under certain extreme conditions. It is the responsibility of the user to ensure that the equipment is installed in a location where it will not be subjected to external conditions that might cause a build-up of electrostatic charge on the surface of the unit.

8.0 Conditions for Use

The Moflash Intrinsically Safe Signalling Range uses an enclosure rated at IP66*. To ensure that this rating is maintained once installed, a suitable cable gland must be used which matches this level of protection. The base of the unit contains 3x M20 knockouts for wiring in purposes and only those required should be used. Any that are removed must have an IP66 rated gland fitted with cable passing through it or suitable plug.

*= meets the IP33C requirements of EN 54-3:2001+A1:2002+A2:2006.

As previously stated in the installations sheet, the Intrinsically Safe Sounder Beacon Range **must** be powered via a suitable Zener Barrier or Galvanic Isolator whose characteristics do not exceed:

Uo:28v, Io: 93mA, Po:660mW

The value for Uo must be between **16v and 28v**, and Io should not be below 50mA.

















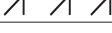











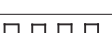

This range of products is only to be powered via a correctly rated Zener Barrier or Galvanic Isolator. To power these units up without the correctly rated barrier could damage these products and so void any protection ratings.

Specific Conditions of Use:

1. Clean equipment regularly to prevent dust build-up with a damp or anti-static cloth only.
2. Equipment only suitable for fixed installation.
3. It must be ensured that the equipment is installed in accordance with IEC 60079-14 and IEC 60079-25 and that capacitance and inductance limits are not exceeded by distributed capacitance (Cc) or distributed inductance (Ic) due to cable length.

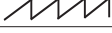
Table of Entity Parameters	
Parameter	Barrier Supply
Ui	28V
Ii	93 mA
Pi	660 mW
Li	0
Ci	0

9.0 Tone Table

TONE	TONE TYPE	TONE DESCRIPTION/ APPLICATION	DIP SWITCH						dB(A) @ 1m	
			1	2	3	4	5	6		
1.		970Hz	0	0	0	0	0	0	87	
2.		800Hz/970Hz @ 2Hz	0	0	0	0	0	1	0	91
3.		800Hz – 970Hz @ 1Hz	0	0	0	0	1	0	0	91
4.		970Hz 1s OFF/1s ON	0	0	0	0	1	1	0	92
5.		970Hz, 0.5s/ 630Hz, 0.5s	0	0	1	0	0	0	0	92
6.		554Hz, 0.1s/ 440Hz, 0.4s (AFNOR NF S 32 001)	0	0	1	0	1	0	0	89
7.		500 – 1200Hz, 3.5s/ 0.5s OFF (NEN 2575:2000 Dutch Slow Whoop)	0	0	1	1	0	0	0	90
8.		420Hz 0.6s ON/0.6s OFF (Australia AS1670 Alert tone)	0	0	1	1	1	0	0	93
9.		1000 - 2500Hz, 0.5s/ 0.5s OFF x 3/1.5s OFF (AS1670 Evacuation)	0	1	0	0	0	0	0	97
10.		550Hz/440Hz @ 0.5Hz	0	1	0	0	0	1	0	94
11.		970Hz, 0.5s ON/0.5s OFF x 3/ 1.5s OFF (ISO 8201)	0	1	0	1	0	0	0	92
12.		2850Hz, 0.5s ON/0.5s OFF x 3/1.5s OFF (ISO 8201)	0	1	0	1	1	0	0	90
13.		1200Hz – 500Hz @ 1Hz (DIN 33 404)	0	1	1	0	0	0	0	89
14.		400Hz	0	1	1	0	1	0	0	92
15.		550Hz, 0.7s/1000Hz, 0.33s	0	1	1	1	0	0	0	93
16.		1500Hz – 2700Hz @ 3Hz	0	1	1	1	1	0	0	98
17.		750Hz	1	0	0	0	0	0	0	93
18.		2400Hz	1	0	0	0	0	1	0	105
19.		660Hz	1	0	0	1	0	0	0	93
20.		660Hz 1.8s ON/1.8s OFF	1	0	0	1	1	0	0	93
21.		660Hz 0.15s ON/0.15s OFF	1	0	1	0	0	0	0	93
22.		510Hz, 0.25s/ 610Hz, 0.25s	1	0	1	0	1	0	0	92
23.		800/1000Hz 0.5s each (1Hz)	1	0	1	1	0	0	0	95
24.		250Hz – 1200Hz @ 12Hz	1	0	1	1	1	0	0	91
25.		500Hz – 1200Hz @ 0.33Hz	1	1	0	0	0	0	0	95
26.		2400Hz – 2900Hz @ 9Hz	1	1	0	0	0	1	0	90
27.		2400Hz – 2900Hz @ 3Hz	1	1	0	1	0	0	0	90
28.		500 - 1200Hz, 0.5s/ 0.5s OFF x 3/1.5s OFF (AS1670 Evacuation)	1	1	0	1	1	0	0	93
29.		800Hz – 970Hz @ 9Hz	1	1	1	0	0	0	0	95
30.		800Hz – 970Hz @ 3Hz	1	1	1	0	1	0	0	95
31.		800Hz, 0.25s ON/1s OFF	1	1	1	1	0	0	0	92
32.		500Hz – 1200Hz, 3.75s/0.25s OFF (AS2220)	1	1	1	1	1	0	0	96

Note:EN54-3 Compatible Tones are 1,2,3,6,7 & 13

All dB readings have been taken with Intrinsicly safe barrier in place, dB readings are ±3dB(A).

For EN54-3 Sound Pressure Level Data see Document MOIS02